

- > Port size: Ø 3, 4 and 6 mm O/D tube
- > Miniature Pneufit® M an ultra compact alternative where space is at a premium.
- > Releasable stainless-steel grab-ring to grip
- > PA or PUR tube (85 or 95 durometer).

- > Nickel plated brass components provide corrosion and contamination resistance and an extended life.
- > Pre applied thread sealant on all taper threads and recessed captive O-ring on parallel threads provides optimum rapid sealing.



Technical features

Medium:

Compressed air

Operating pressure:

10 bar (145 psi) max.

Vacuum:

750 mmHg

Tube sizes:

3, 4, and 6 mm

Thread sizes:

M3, M5, M6, R1/8 and Rc1/8

Tubing types:

PA 11 or 12

PUR 85, 95 or 98 durometer

Ambient/Media temperature:

-20°C ... +60°C (+32 ... +140°F)

Materials:

Body: PBT

Seals: NBR (VMQ free)

u-packing and O-rings

Threaded bodies: nickel plated brass

Backing ring: POM

Grab-ring: stainless steel

Collar: nickel plated brass

Thread sealant: Chemitech

G-175L

Method of assembly



1. Ensure that the end of the tube is cut square and is free from burrs.



2. Push the tube through the collet into the fitting.

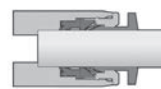

3. Continue pushing the tube through the 'O'-ring until it bottoms on the tube stop then pull back.

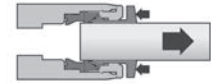

4. To disconnect push the tube into the fitting, hold down the collet and withdraw the tube.

Components

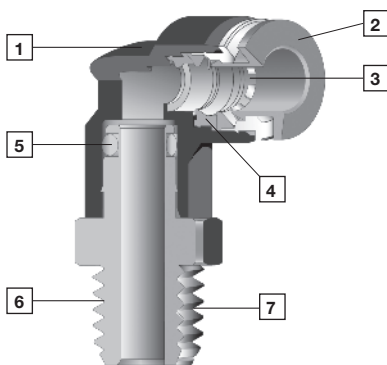

- 1 Impact resistant PBT body in grey
- 2 Release buttons are grey
- 3 Stainless steel grab ring with special design to retain softer tube and provide easy releasability.
- 4 Silicon free U-packing provides leak tight tube seal under side loading.
- 5 Stem seal provides leak tight 360° swivel connection.
- 6 Nickel plated brass threads
- 7 Pre-applied thread sealant on tapered threads and recessed captive O-ring on parallel threads.

Option selector

M0 ★★★★★★



Typical dimensions

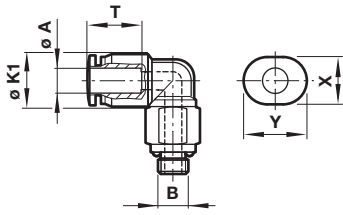

Ø A	Ø K1	T	X	Y
3	7,5	11,5	7	9
4	8,5	12	8	10,5
6	11	13	10	12,5

B	Recommended torque
M3	0,7 Nm
M5	1,5 Nm
M6	2,3 Nm
R1/8	7 Nm

Straight adaptors and connectors

Straight union (equal)
M0020



Page 3

Straight union (unequal)
M0020



Page 3

Straight adaptor (external hex only)
M0125/M0225



Page 3

Straight adaptor (internal hex only)
M012A/M022A



Page 3

Straight adaptor
M0126/M0226



Page 3

Elbow adaptors and connectors

Union elbow
M0040



Page 3

90° Swivel elbow adaptor
M0147/M0247



Page 3

Union tee
M0060



Page 5

Swivel tee adaptor
M0167/M0267



Page 5

Swivel side tee adaptor
M0168/M0268



Page 5

Y connectors

Union Y (equal)
M0082



Page 5

Union Y (unequal)
M0082

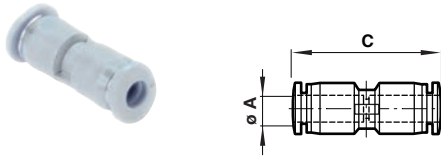

Page 5

Straight union
M0020

Equal

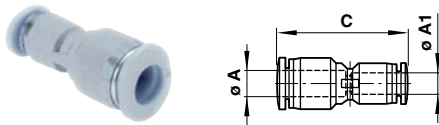
Ø A	C	Model
3	23,5	M00200300
4	26	M00200400
6	26,5	M00200600

Unequal

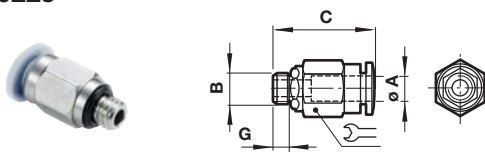
Ø A	A1	C	Model
4	3	24	M00200403
6	3	24	M00200603
6	4	26,5	M00200604

Straight adaptor (external hex only)
M0125, M0225

Ø A	B	C	G	⌘	Model
3	M3	17	4	7	M02250303
3	M5	17,5	4,5	8	M02250305
3	M6	18	5	8	M02250306
4	M3	17,5	4	8	M02250403
4	M5	18	4,5	8	M02250405
4	M6	19	5	8	M02250406
4	R1/8	19	6	12	M01250418
6	M5	19,5	4,5	10	M02250605
6	M6	20	5	10	M02250606
6	R1/8	19,5	8	12	M01250618

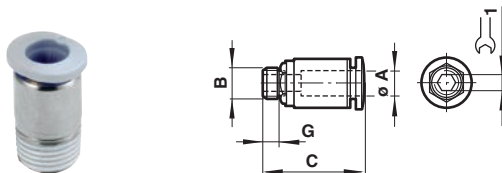
Straight adaptor (internal hex only)
M012A, M022A

Ø A	B	C	G	⌘	Model
3	M3	17	4	1,5	M022A0303
3	M5	17,5	4,5	2	M022A0305
3	M6	18	5	2	M022A0306
4	M3	17,5	4	1,5	M022A0403
4	M5	19	4,5	2,5	M022A0405
4	M6	19	5	3	M022A0406
4	R1/8	17,5	8	3	M012A0418
6	M5	19,5	4,5	2,5	M022A0605
6	M6	20	5	3	M022A0606
6	R1/8	19,5	8	2,5	M012A0618

Straight adaptor (female thread)
M0126, M0226

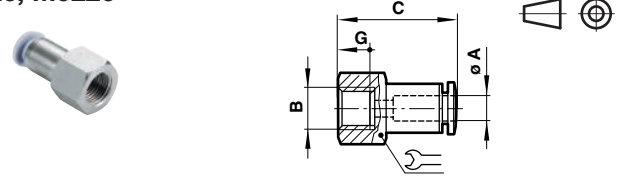
 Dimensions in mm
 Projection/First angle

Ø A	B	C	G	⌘	Model
3	M3	17,5	4	8	M02260303
3	M5	19	6	8	M02260305
3	M6	19	6	8	M02260306
4	M3	18	4	8	M02260403
4	M5	19,5	6	8	M02260405
4	M6	19,5	6	8	M02260406
4	Rc1/8	23	8,5	12	M01260418
6	M5	21,5	6	10	M02260605
6	M6	21,5	6	10	M02260606
6	Rc1/8	25,5	8,5	12	M01260618

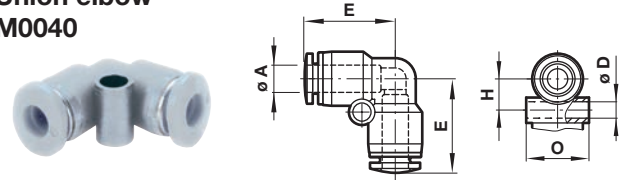
Union elbow
M0040

Ø A	Ø D	E	H	O	Model
3	3,2	13,5	5,5	7,5	M00400300
4	3,2	14,5	6	8,5	M00400400
6	3,2	16,5	7	10,5	M00400600

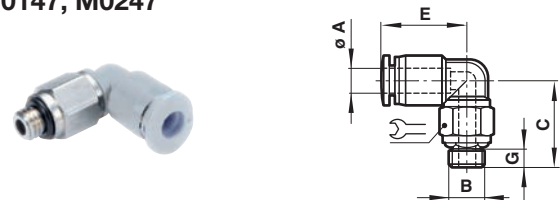
90° Swivel elbow adaptor
M0147, M0247

Ø A	B	C	E	G	⌘	Model
3	M3	16	13,5	3	8	M02470303
3	M5	17	13,5	4	8	M02470305
3	M6	17	13,5	4	8	M02470306
4	M3	16	14,5	3	8	M02470403
4	M5	17	14,5	4	8	M02470405
4	M6	17	14,5	4	8	M02470406
4	R1/8	18	14,5	6	14	M01470418
6	M5	17	15,5	3,5	8	M02470605
6	M6	17	15,5	4	8	M02470606
6	R1/8	18	15,5	5	14	M01470618

**Union T
M0060**

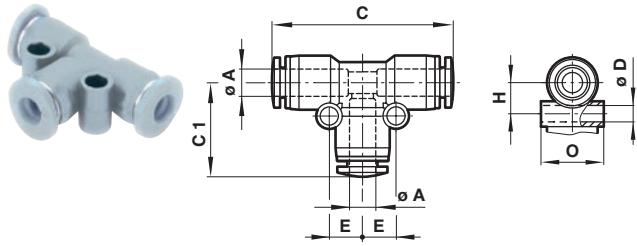

Ø A	C	C1	Ø D	E	H	O	Model
3	26,5	13,5	3,2	5,5	5,5	7,5	M00600300
4	28,5	14,5	3,2	6	6	8,5	M00600400
6	33	16,5	3,2	7	7	10,5	M00600600

**Swivel side tee adaptor
M0168, M0268**

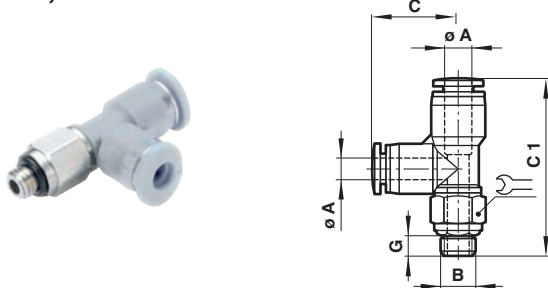

Ø A	B	C	C1	G	Model
3	M3	13,5	29,5	3	M02680303
3	M5	13,5	30	4	M02680305
3	M6	13,5	30,5	4	M02680306
4	M3	14	30,5	3	M02680403
4	M5	14	31	3,5	M02680405
4	M6	14	31,5	4	M02680406
4	R1/8	14	31,5	6	M01680418
6	M5	16,5	33,5	3,5	M02680605
6	M6	16,5	34	4	M02680606
6	R1/8	16,5	33,5	6	M01680618

Warning

These products are intended for use in industrial compressed air systems only. Do not use these products where pressures and temperatures can exceed those listed under »Technical features/data«.

Before using these products with fluids other than those specified, for non-industrial applications, life-support systems or other applications not within published specifications, consult IMI NORGREN.

Through misuse, age, or malfunction, components used in fluid power systems can fail in various modes.

**Swivel tee adaptor
M0167, M0267**

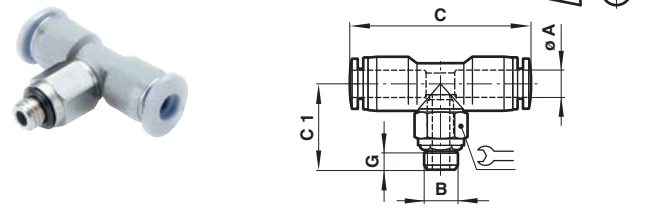

Ø A	B	C	C1	G	Model
3	M3	25,5	16	3	M02670303
3	M5	29	17	4	M02670305
3	M6	27	17	4	M02670306
4	M3	28,5	16	3	M02670403
4	M5	28,5	17	3,5	M02670405
4	M6	29	17	4	M02670406
4	R1/8	29	18	6	M01670418
6	M5	31	17	3,5	M02670605
6	M6	31	17	4	M02670606
6	R1/8	31	18	6	M01670618

**Union Y
M0082**

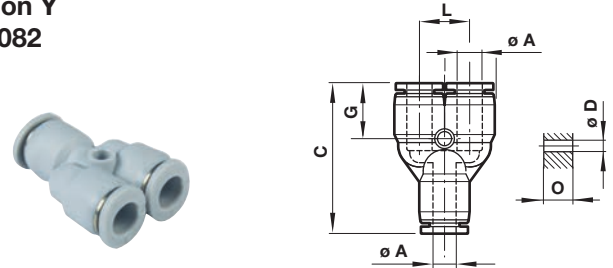

Equal

Ø A	C	D	H	L	O	Model
3	27	3,2	11	8	7,5	M00820300
4	28	3,2	11,5	9	8,5	M00820400
6	31	3,2	12	11,5	11	M00820600

Unequal

Ø A	Ø A1	C	D	G	L	O	Model
4	3	27,5	3,2	11	8	8,5	M00820403
6	3	28,5	3,2	11	8	11	M00820603
6	4	29	3,2	11,5	9	11	M00820604

The system designer is warned to consider the failure modes of all component parts used in fluid power systems and to provide adequate safeguards to prevent personal injury or damage to equipment in the event of such failure.

System designers must provide a warning to end users in the system instructional manual if protection against a failure mode cannot be adequately provided.

System designers and end users are cautioned to review specific warnings found in instruction sheets packed and shipped with these products.